

• MATERIALS:(RoHS Compliant)

Hood: Plastic Thermoplastic ABS UL 94V-0  
 Jackscrews: Steel Nickel Plated Over Copper  
 Jackscrews Hood: PVC  
 Inner Shell: Steel Nickel Plated Over Copper

• MATERIALS:(RoHS Compliant)

Housing: Plastic Thermoplastic  
 P.B.T UL94V-0 Black  
 Contacts: Phosphor Bronze Gold  
 Selective Plated  
 Front Shell: Steel Nickel Plated  
 Over Copper

• ELECTRICAL CHARACTERISTICS:

Contact Current Rating: 1 Amp  
 Dielectric Withstanding Voltage: 500V AC  
 Insulation Resistance: >500MΩ/Min  
 Contact Resistance: 35mΩ/Max  
 Operation Temperature: -55°C ~ +105°C

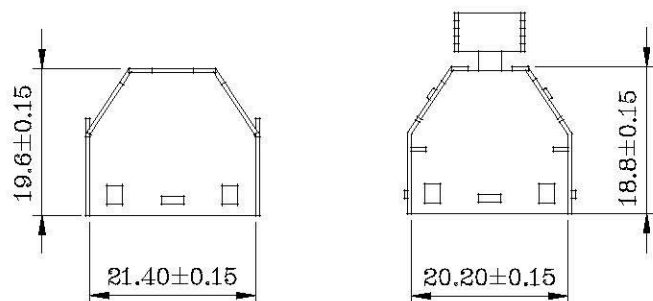

HPD-PSMBK-020-LF  
 LEADFREE  
 RoHS Compliant

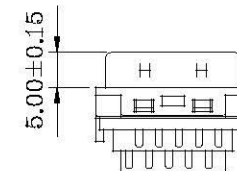
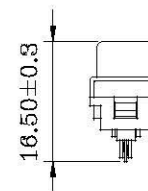
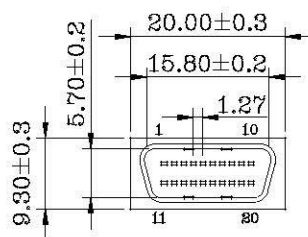
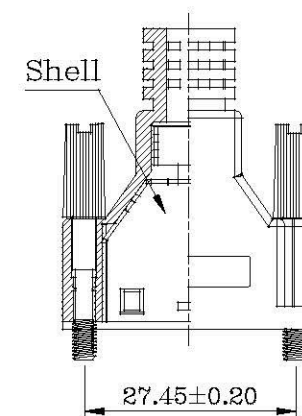
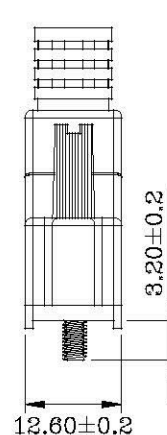
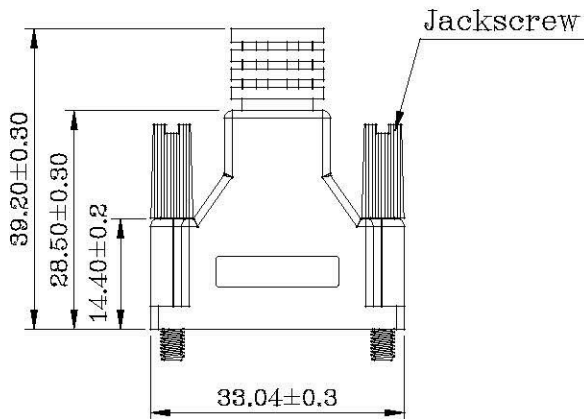
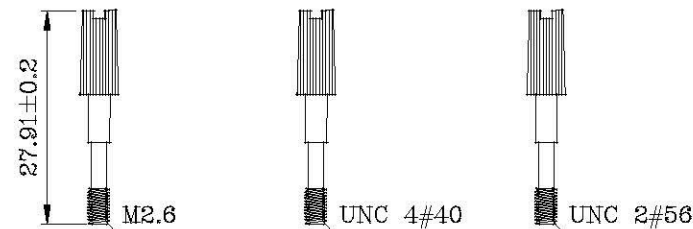
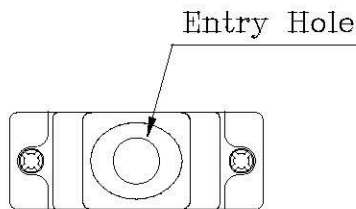

**All Connectors**

www.allconnectors.de  
 Tel.: 0049 711 7009503  
 70791 Hilderstadt - Germany

info@allconnectors.de  
 Fax: 0049 711 7009504  
 Kettnerstr. 2a

PART NO. HPD-PSMBK-020

DWG NO. HPD-PSMBK-020

FILE NO.

UNIT / mm

SCALE 1:1

CHECKED BY CY

DRAWING BY

PROJECTION



TOLERANCES ARE

X ± 0.2  
 .XX ±  
 .XXX ±  
 AWG

DESCRIPTION:

AREA

REVISIONS

HK

DATE